



SEALLESS

# DRUM PUMPS ALU

FOR NEUTRAL LIQUIDS IN ALL INDUSTRIES  
THE RIGHT DRUM PUMPS



- This saves maintenance costs
- This avoids malfunctions
- This saves time
- This saves money

# Aluminium has a wide range of applications: from vinegrowing to petroleum industry...



Here it is a pleasure to work...



...and drum pumps.

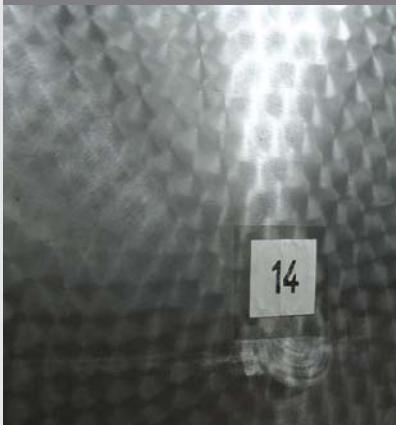

for people...



## Advantages for the reliability

### This saves maintenance costs

- robust coupling
- strong shaft
- stainless steel for stressed parts
- new development without seal



## Advantages for the operational safety

### This avoids malfunctions

- optional magnetic clutch for hermetical sealed pump
- strong connection motor-pump



## Advantages for the user

### This saves time

- quick release coupling
- no problems with failed threads



## Advantages for the customer

### This saves money

- one supplier for the most applications
- one motor for all types of impeller
- less equipment required

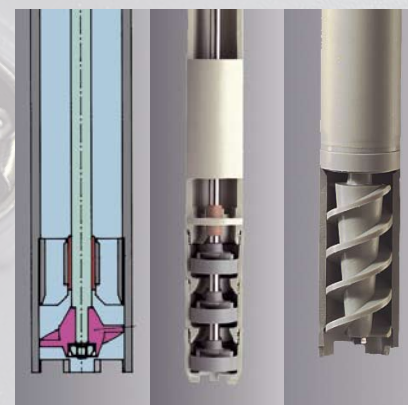



# DRUM PUMPS ALU

FOR NEUTRAL LIQUIDS IN ALL INDUSTRIES  
THE RIGHT DRUM PUMPS

## SEALLESS

- 
- **diesel oil**
  - **biomass fuel**
  - **mineral oil**
  - **colours**
  - emulsions
  - dispersions
  - suspensions
  - fluids of medium viscosity
  - cosmetics
  - food



### For neutral liquids...

Version A, R column 1-2, page 7



### For fluids of medium viscosity...

Version S column 3, page 7

#### **SL-Alu:**

For transfilling and draining of drums and containers.

Version A for high flow rate,

Version R for high pressure.

#### **Recommendation:**

The multi-purpose combination;

SL-Alu-R with the powerful motor P400-A.

#### **SL-Alu-S:**

The feed screw (S) is dedicated for liquids of medium viscosity ( $\eta > 200$  mPas), if the impeller types A and R reach their limitations.

With induction motor ideal combination for gentle dealing with the liquid.

#### **Recommendation:**

Induction motor with frequency inverter for variable flow rate.

## Sealless pumping units

Sealless pump tubes from grün are reliable without using a mechanical seal and are suitable for almost any aggressive, low viscosity media. Our sealless pumping units are available in PP, PVDF, stainless steel (SS) and aluminium (Alu) material versions.

(Separate brochure for each material available).

### Design Alu:

The pump tube (3) is divided by the inner tube into sections to separate the fluid under pressure (3 flow channels) and the low pressure section (wave channel).

This wave channel is connected to the surrounding fluid area by a surge hole to relieve or compensate the pressure.

### Advantages of sealless drum pumps

- ▶ Cleaning the pumping unit is greatly facilitated; the risk of fluid carry-over when moving the pump to a different container is minimized.

- ▶ No bearings in the wave channel.

- ▶ Motor power is transferred by proven, robust coupling (1) with curved teeth over the stainless steel coupling element (2) with a large double bearing.

- ▶ Of course, the sealless pump tubes are fully compatible with the sealed models, allowing you to use the pumping units with any motor from grün product range.

- ▶ Depending on the application you can select one of 3 different types of impellers: axial (A), radial (R) and feed screw (S).

### Product profile

A drum pump always consists of a pump tube and a motor. These components are connected by means of a quick coupling. Any pump tube can be used with any motor.

#### Selecting the right order-no.

In the general order-no., for example 500-00XX, fill in the specific numbers for your choice.

Example: p310-A 230V:                      Order-No. 500-0017



- **optimised in price**
- **short and occasional usage**
- **it likes light and thin liquids**
- **opt. LVR: low voltage release for advanced safety**
- **opt. SR: speed reducer for simple flow rate variation**

Motor		Pump tube
p310		Performance curve
Power (W)	520	Hydr. Values
Voltage (V)	230 / 120	Capacity Q (l/min)
Protection	IP 24	Delivery head H (mWS)
LVR*	optional	Density ϕ (kg/l)
		Viscosity η (mPas)
Weight (kg)	3,5	Weight (kg)
		Temperature (°C)
Order-No.	500-00XX	L (mm)
Voltage (V)	230 120	700
p310 (LVR)	16 28	1000
p310-A	17 29	1200
p310-A-SR	54 -	



- **the ideal drive**
- **big resources in power and durability**
- **quick working and saving time**
- **opt. LVR: low voltage release for advanced safety**
- **opt. SR: speed reducer for simple flow rate variation**
- **opt. IP 54: 230V**
- **Order-No. 500-0052**

Motor		Pump tube
p400		Performance curve
Power (W)	850	Hydr. Values
Voltage (V)	230 / 120	Capacity Q (l/min)
Protection	IP 24	Delivery head H (mWS)
LVR*	optional	Density ϕ (kg/l)
		Viscosity η (mPas)
Weight (kg)	4	Weight (kg)
		Temperature (°C)
Order-No.	500-00XX	L (mm)
Voltage (V)	230 120	700
p400 (LVR)	23 25	1000
p400-A	24 26	1200
p400-A-SR	56 -	



- **the power drive**
- **variable speed**
- **starting knob fixable**
- **for heavy duty**
- **easy handling**
- **economical air consumption**

Motor		Pump tube
d600		Performance curve
Power (W)	600	Hydr. Values
Pressure (bar)	3-7	Capacity Q (l/min)
		Delivery head H (mWS)
Consumption of air (l/s)	10	Density ϕ (kg/l)
Weight (kg)	1,7	Viscosity η (mPas)
		Weight (kg)
		Temperature (°C)
	Order-No.	L (mm)
d600	520-0016	700
		1000
		1200



- **the silent marathon worker**
- **ideal for viscous liquids**
- **smooth product treatment with feed screw**
- **voltage 230 V (1-ph) and 400 V (3-ph)**
- **opt.: with frequency inverter**
- **opt.: Ex-proof versions**

Motor		Pump tube
pd500		Performance curve
Power (W)	s. below	Hydr. Values
Voltage (V)	230 / 400	Capacity Q (l/min)
Protection	IP 54	Delivery head H (mWS)
Overload release	1-ph: yes 3-ph opt.	Density ϕ (kg/l)
Weight (kg)	5	Viscosity η (mPas)
		Weight (kg)
		Temperature (°C)
	Order-No.	L (mm)
d500-1 370W	500-0042	700
		1000
d500-3 370W	500-0039	1200

1	2	3
SL-Alu-A	SL-Alu-R	SL-Alu-S
A110	R110	
max	max	
110	90	
6	14	
1,3	1,6	
300	250	
1,5	1,5	
80	80	
Order-No.	Order-No.	
600-0014	605-0013	
600-0015	605-0014	
600-0016	605-0015	

1	2	3
SL-Alu-A	SL-Alu-R	SL-Alu-S
A210	R210	S210
max	max	max
150	110	60
8	21	10
1,6	2	1,5
800	700	700
1,5	1,5	1,5
80	80	80
Order-No.	Order-No.	Order-No.
600-0014	605-0013	600-0018
600-0015	605-0014	600-0019
600-0016	605-0015	600-0020

1	2	3
SL-Alu-A	SL-Alu-R	SL-Alu-S
A610	R610	S610
max	max	max
120	80	65
8	17	8
1,6	2	1,5
800	700	1500 (min 100)
1,5	1,5	1,5
80	80	80
Order-No.	Order-No.	Order-No.
600-0014	605-0013	600-0018
600-0015	605-0014	600-0019
600-0016	605-0015	600-0020

1	2	3
SL-Alu-A	SL-Alu-R	SL-Alu-S
		S500
		max
		15
		7
		1,5
		1500 (min 100)
		1,5
		50
		Order-No.
		600-0018
		600-0019
		600-0020

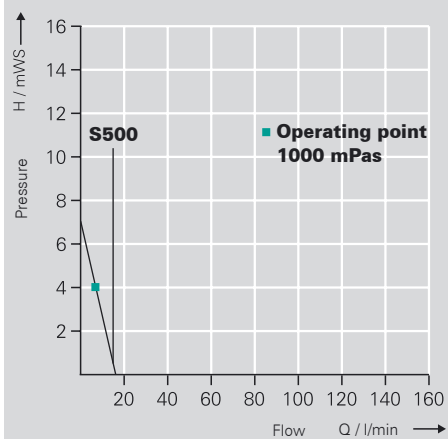
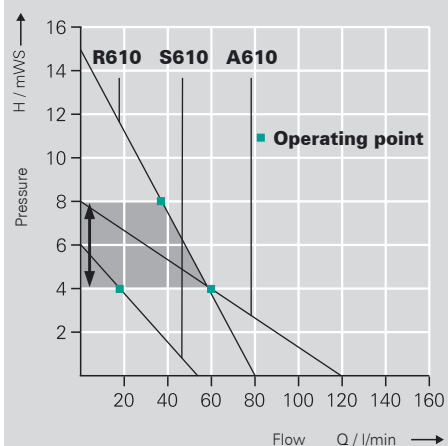
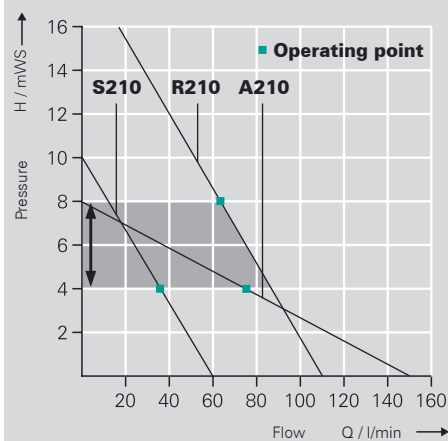
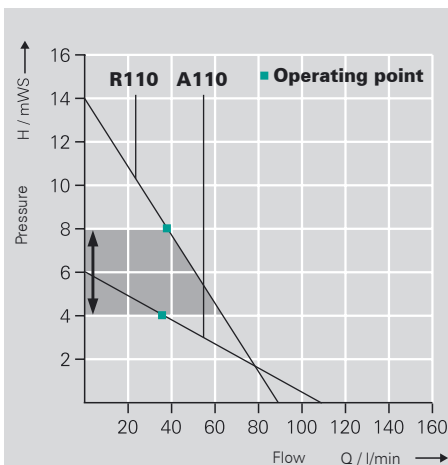

## Table of materials

Description	Pump tube version Alu
1. Curved teeth coupling	PA
2. Coupling element	Alu
3. Pump tube with flow and wave channel	Alu
4. Drive shaft	SS
5. Wave channel	Alu
6. Slide bearing	Carbon
7. Impeller	ETFE

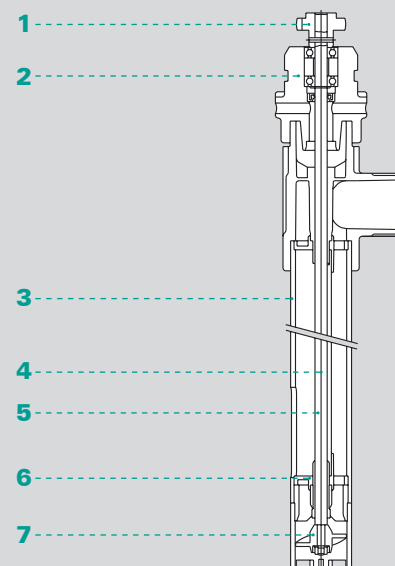

Cross-section of pump:

When fluid enters the wave channel, a surge hole allows it to escape into the fluid area surrounding the pumping unit. In the wave channel is no overpressure and the fluid level in both (wave channel and drum) is always the same. For this reason the pump doesn't need a seal between drive shaft and housing.

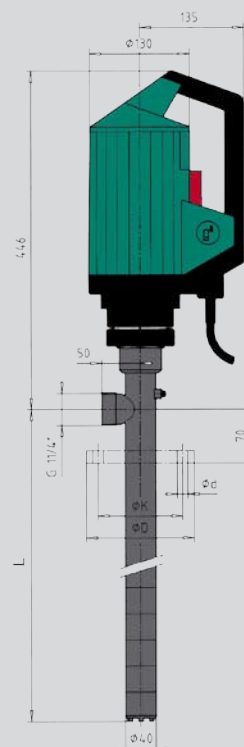

**Mechanical sealed (MS) pumps  
in separate catalogue.**



# ACCESSORIES

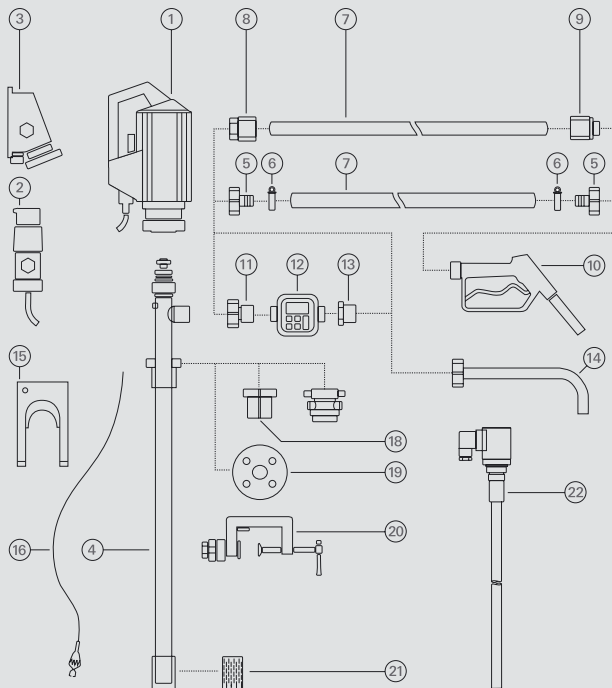

- 1 Drive motor
- 2 Explosion-proof plug
- 3 Explosion-proof socket
- 4 Pump tube
- 5 Hose connector
- 6 Hose clamps
- 7 Hose
- 8 Hose fittings
- 9 Hose fittings
- 10 Nozzle
- 11 Flow meter connection
- 12 Flow meter
- 13 Reducing piece
- 14 Discharge spout
- 15 Wall bracket
- 16 Equipotential bounding cable
- 17 Emission proof drum adapter
- 18 Drum adapter
- 19 Installation flange
- 20 Clamping device
- 21 Foot strainer
- 22 Level switch

Distributor:

**grün-pumpen gmbh**  
**Zum Ottersberg 12**  
**D-97877 Wertheim-Reicholzheim**  
 phone +49 93 42 / 3 08-761  
 fax +49 93 42 / 3 08-790  
 info@gruen-pumpen.de  
 www.gruen-pumpen.de