



SEALLESS

DRUM PUMPS PP

FOR AGGRESSIVE LIQUIDS
THE RIGHT DRUM PUMPS



- This saves maintenance costs
- This avoids malfunctions
- This saves time
- This saves money

The most popular model for the most applications in drums and containers and technical objects...



PP drum pumps...



...for acids and bases.



are the basis ...



Advantages for the reliability

This saves maintenance costs

- robust coupling
- strong shaft
- stainless steel for stressed parts
- new development without seal



Advantages for the operational safety

This avoids malfunctions

- optional magnetic clutch for hermetical sealed pump
- strong connection motor-pump



Advantages for the user

This saves time

- quick release coupling
- no problems with failed threads



Advantages for the customer

This saves money

- one supplier for the most applications
- one motor for all types of impeller
- less equipment required

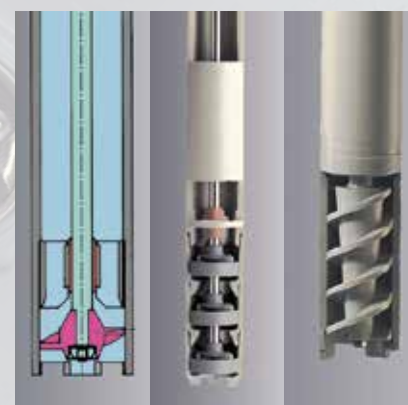



DRUM PUMPS PP

FOR AGGRESSIVE LIQUIDS
THE RIGHT DRUM PUMPS

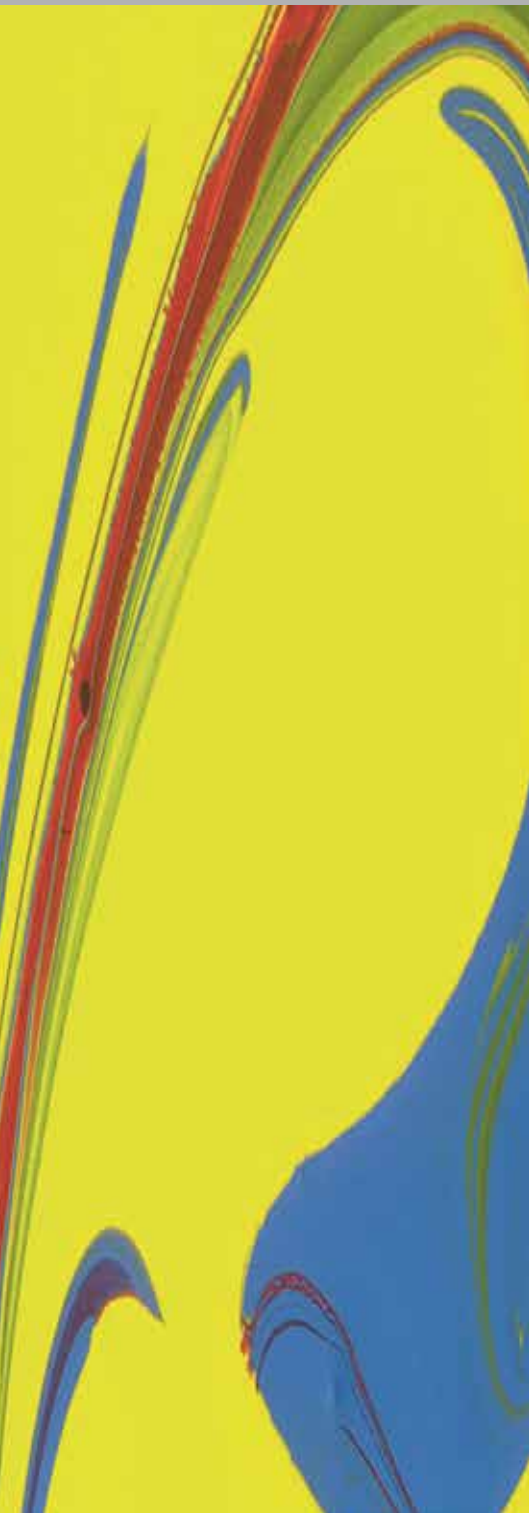

SEALLESS

- **acids, low concentrated**
- **bases, low concentrated**
- colours
- emulsions
- dispersions
- suspensions
- fluids of medium viscosity
- cosmetics



For aggressive* liquids...

Versions A, R column 1-2, page 7

If the liquid has to be mixed...

Series MP
Versions A, R column 4, page 7

For liquids of medium viscosity...

Version S column 3, page 7

SL-PP:

For transfilling and draining of drums and containers.

The perfect drum pump for the most thin liquids. Version A for high flow rate, Version R for high pressure, with foot valve for complete drainage.

Recommendation:

SL-PP-R-HC with motor p400-A.

*with drive shaft hastelloy C (HC) there are no problems with aggressive liquids

SL-MP-PP:

For stirring of emulsions, dispersions, suspensions, etc. before starting the transfilling action.

The mixing drum pump is fitted with mixing apertures. By moving a sliding sleeve with a lever, these holes can be opened or closed.

„Open“ is for mixing inside the drum and „closed“ is for pumping out of the drum. All this can be achieved with one unit.

Recommendation:

For a good stirring effort use the powerful motor p400-A.

SL-PP-S:

The feed screw (S) is dedicated for liquids of medium viscosity ($\eta > 200$ mPas), if the impeller types A and R reach their limitations.

With induction motor ideal combination for gentle dealing with the liquid.

Recommendation:

Induction motor with frequency inverter for variable flow rate.

Sealless pumping units

Sealless pump tubes from grün are reliable without using a mechanical seal and are suitable for almost any aggressive, low viscosity media. Our sealless pumping units are available in PP, PVDF, stainless steel (SS) and aluminium (Alu) material versions.

(Separate brochure for each material available).



- **optimised in price**
- **short and occasional usage**
- **it likes light and thin liquids**
- **opt. LVR: low voltage release for advanced safety**
- **opt. SR: speed reducer for simple flow rate variation**

Design PP:

The pump tube (3) is divided by the inner tube into sections to separate the fluid under pressure (3 flow channels) and the low pressure section (wave channel).



- **the ideal drive**
- **big resources in power and durability**
- **quick working and saving time**
- **opt. LVR: low voltage release for advanced safety**
- **opt. SR: speed reducer for simple flow rate variation**
- **opt. IP 54: 230V**
- **Order-No. 500-0052**

Advantages of sealless drum pumps

► Cleaning the pumping unit is greatly facilitated; the risk of fluid carry-over when moving the pump to a different container is minimized.

► The build-in webs add considerable rigidity to the pump tube, resulting in greatly improved mechanical stability of the pumping unit.

► No bearings in the wave channel.

► Motor power is transferred by proven, robust coupling (1) with curved teeth over the stainless steel coupling element (2) with a large double bearing.

► Of course, the sealless pump tubes are fully compatible with the sealed models, allowing you to use the pumping units with any motor from grün product range.

► Depending on the application you can select one of 3 different types of impellers: axial (A), radial (R) and feed screw (S).



- **the power drive**
- **variable speed**
- **starting knob fixable**
- **for heavy duty**
- **easy handling**
- **economical air consumption**

Product profile

A drum pump always consists of a pump tube and a motor. These components are connected by means of a quick coupling. Any pump tube can be used with any motor.

Selecting the right order-no.

In the general order-no., for example 500-00XX, fill in the specific numbers for your choice. Example: Order-No. p310-A 230V: 500-0017 SL-PP-A-SS-1000 (SS drive shaft): 670-0002 SL-PP-A-HC-1200 (HC drive shaft): 670-0006



New connection technology: metal replaces plastic, robust for use in harsh environments

- **the silent marathon worker**
- **ideal for viscous liquids**
- **smooth product treatment with feed screw**
- **voltage 230 V (1-ph) and 400 V (3-ph)**
- **opt.: with frequency inverter**
- **opt.: Ex-proof versions**

| Motor | | Pump tube | 1 | | 2 | | 3 | | 4 | | 5 | |
|-------------|-----------|-----------------------|----------|----------|---------|------------|------------|--|---|--|---|--|
| | | | SL-PP-A | SL-PP-R | SL-PP-S | SL-MP PP-A | SL-MP PP-R | | | | | |
| p310 | | Performance curve | A100 | R100 | | A100 | R100 | | | | | |
| Power (W) | 520 | Hydr. Values | max | max | | max | max | | | | | |
| Voltage (V) | 230 / 120 | Capacity Q (l/min) | 100 | 90 | | 100 | 90 | | | | | |
| Protection | IP 24 | Delivery head H (mWS) | 6 | 14 | | 6 | 14 | | | | | |
| LVR* | optional | Density ϕ (kg/l) | 1,3 | 1,6 | | 1,3 | 1,6 | | | | | |
| Weight (kg) | 3,5 | Viscosity η (mPas) | 300 | 250 | | 300 | 250 | | | | | |
| | | Weight (kg) | 1,5 | 1,5 | | 1,5 | 1,5 | | | | | |
| | | Temperature (°C) | 50 | 50 | | 50 | 50 | | | | | |
| Order-No. | 500-00XX | L (mm) | 670-000X | 675-000X | | 670-00XX | 675-00XX | | | | | |
| Voltage (V) | 230 120 | | SS HC | SS HC | | SS HC | SS HC | | | | | |
| p310 (LVR) | 16 28 | 700 | 1 4 | 1 4 | | 19 22 | 37 40 | | | | | |
| p310-A | 17 29 | 1000 | 2 5 | 2 5 | | 20 23 | 38 41 | | | | | |
| p310-A-SR | 54 - | 1200 | 3 6 | 3 6 | | 21 24 | 39 42 | | | | | |

| Motor | | Pump tube | 1 | | 2 | | 3 | | 4 | | 5 | |
|-------------|-----------|-----------------------|----------|----------|----------|------------|------------|--|---|--|---|--|
| | | | SL-PP-A | SL-PP-R | SL-PP-S | SL-MP PP-A | SL-MP PP-R | | | | | |
| p400 | | Performance curve | A200 | R200 | S200 | A200 | R200 | | | | | |
| Power (W) | 850 | Hydr. Values | max | max | max | max | max | | | | | |
| Voltage (V) | 230 / 120 | Capacity Q (l/min) | 110 | 100 | 60 | 110 | 100 | | | | | |
| Protection | IP 24 | Delivery head H (mWS) | 8 | 20 | 10 | 8 | 20 | | | | | |
| LVR* | optional | Density ϕ (kg/l) | 1,6 | 2 | 1,5 | 1,6 | 2 | | | | | |
| Weight (kg) | 4 | Viscosity η (mPas) | 800 | 700 | 700 | 800 | 700 | | | | | |
| | | Weight (kg) | 1,5 | 1,5 | 1,5 | 1,5 | 1,5 | | | | | |
| | | Temperature (°C) | 50 | 50 | 50 | 50 | 50 | | | | | |
| Order-No. | 500-00XX | L (mm) | 670-000X | 675-000X | 670-00XX | 670-00XX | 675-00XX | | | | | |
| Voltage (V) | 230 120 | | SS HC | SS HC | SS HC | SS HC | SS HC | | | | | |
| p400 (LVR) | 23 25 | 700 | 1 4 | 1 4 | 09 13 | 19 22 | 37 40 | | | | | |
| p400-A | 24 26 | 1000 | 2 5 | 2 5 | 19 14 | 20 23 | 38 41 | | | | | |
| p400-A-SR | 56 - | 1200 | 3 6 | 3 6 | 11 15 | 21 24 | 39 42 | | | | | |

| Motor | | Pump tube | 1 | | 2 | | 3 | | 4 | | 5 | |
|--------------------------|----------|-----------------------|----------|----------|----------|------------|------------|--|---|--|---|--|
| | | | SL-PP-A | SL-PP-R | SL-PP-S | SL-MP PP-A | SL-MP PP-R | | | | | |
| d600 | | Performance curve | A600 | R600 | S600 | A600 | R600 | | | | | |
| Power (W) | 600 | Hydr. Values | max | max | max | max | max | | | | | |
| Pressure (bar) | 3-7 | Capacity Q (l/min) | 90 | 80 | 60 | 90 | 80 | | | | | |
| Consumption of air (l/s) | 10 | Delivery head H (mWS) | 6 | 11 | 6 | 6 | 11 | | | | | |
| Weight (kg) | 1,7 | Density ϕ (kg/l) | 1,6 | 2 | 1,5 | 1,6 | 2 | | | | | |
| | | Viscosity η (mPas) | 800 | 700 | 700 | 800 | 700 | | | | | |
| | | Weight (kg) | 1,5 | 1,5 | 1,5 | 1,5 | 1,5 | | | | | |
| | | Temperature (°C) | 50 | 50 | 50 | 50 | 50 | | | | | |
| Order-No. | | L (mm) | 670-000X | 675-000X | 670-00XX | 670-00XX | 675-00XX | | | | | |
| d600 | 520-0016 | 700 | 1 4 | 1 4 | 09 13 | 19 22 | 37 40 | | | | | |
| | | 1000 | 2 5 | 2 5 | 19 14 | 20 23 | 38 41 | | | | | |
| | | 1200 | 3 6 | 3 6 | 11 15 | 21 24 | 39 42 | | | | | |

| Motor | | Pump tube | 1 | | 2 | | 3 | | 4 | | 5 | |
|--------------|-----------|-----------------------|---------|---------|----------------|------------|------------|--|---|--|---|--|
| | | | SL-PP-A | SL-PP-R | SL-PP-S | SL-MP PP-A | SL-MP PP-R | | | | | |
| pd500 | | Performance curve | | | S500 | | | | | | | |
| Power (W) | see below | Hydr. Values | | | max | | | | | | | |
| Voltage (V) | 230 / 400 | Capacity Q (l/min) | | | 20 | | | | | | | |
| Protection | IP 54 | Delivery head H (mWS) | | | 6 | | | | | | | |
| Overload | 1-ph: yes | Density ϕ (kg/l) | | | 1,5 | | | | | | | |
| release | 3-ph opt. | Viscosity η (mPas) | | | 1500 (min 100) | | | | | | | |
| Weight (kg) | 5 | Weight (kg) | | | 1,5 | | | | | | | |
| | | Temperature (°C) | | | 50 | | | | | | | |
| Order-No. | | L (mm) | | | 670-00XX | | | | | | | |
| pd500-1 550W | 500-0044 | 700 | | | SS HC | | | | | | | |
| pd500-3 370W | 500-0039 | 1000 | | | 10 14 | | | | | | | |
| | | 1200 | | | 11 15 | | | | | | | |

* LVR: Low voltage release (restart protection)

Other voltages on demand.

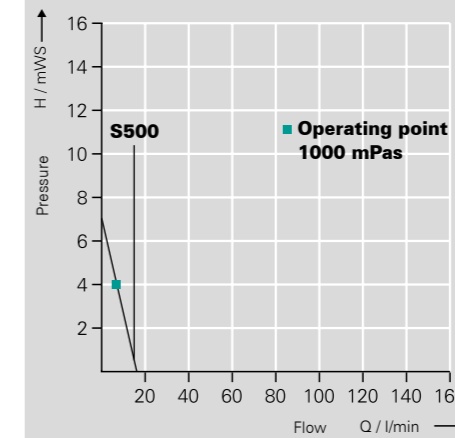
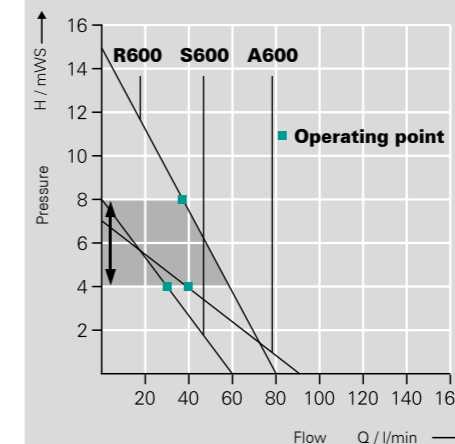
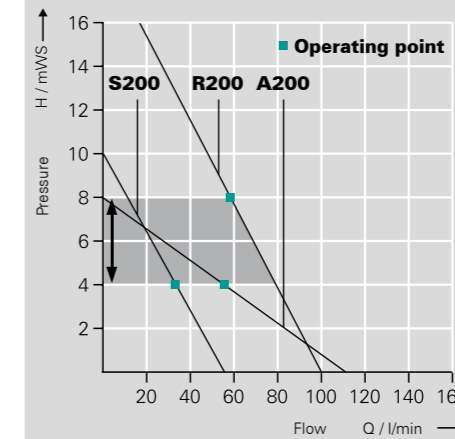
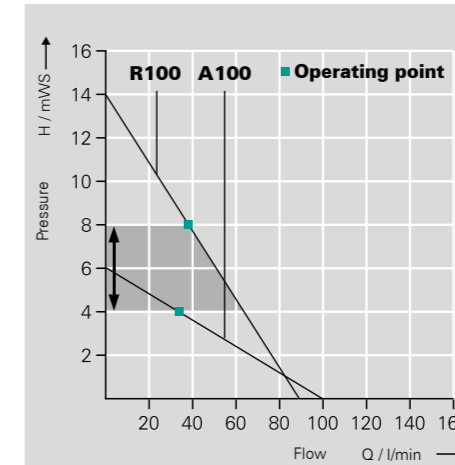
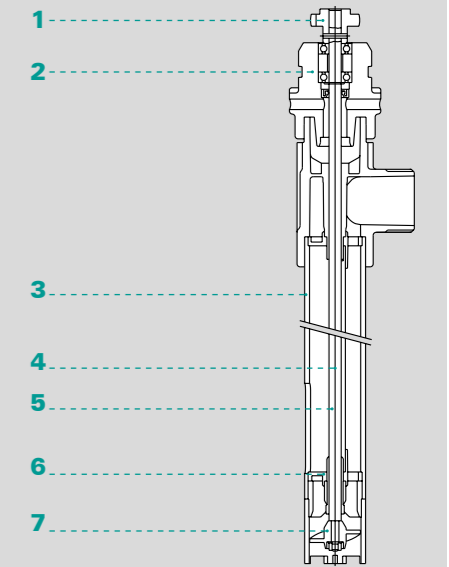

Table of materials

| Description | Pump tube version |
|---|-------------------|
| 1. Curved teeth coupling | PA |
| 2. Coupling element | PP/SS |
| 3. Pump tube with flow and wave channel | PP |
| 4. Drive shaft opt. | SS or HC |
| 5. Wave channel | PP |
| 6. Slide bearing | PTFE |
| 7. Impeller | PP |



Cross-section of pump:

When fluid enters the wave channel, a surge hole allows it to escape into the fluid area surrounding the pumping unit. In the wave channel is no overpressure and the fluid level in both (wave channel and drum) is always the same. For this reason the pump doesn't need a seal between drive shaft and housing.

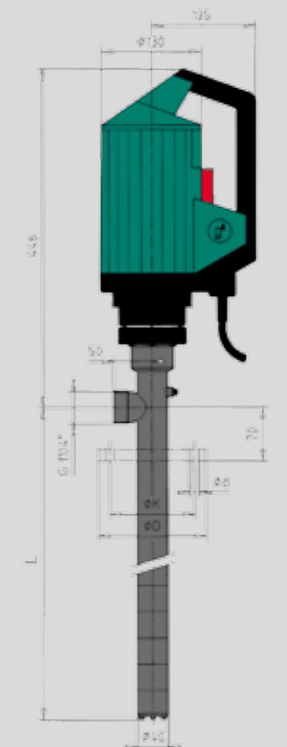

**Mechanical sealed (MS) pumps
in separate catalogue.**



ACCESSORIES

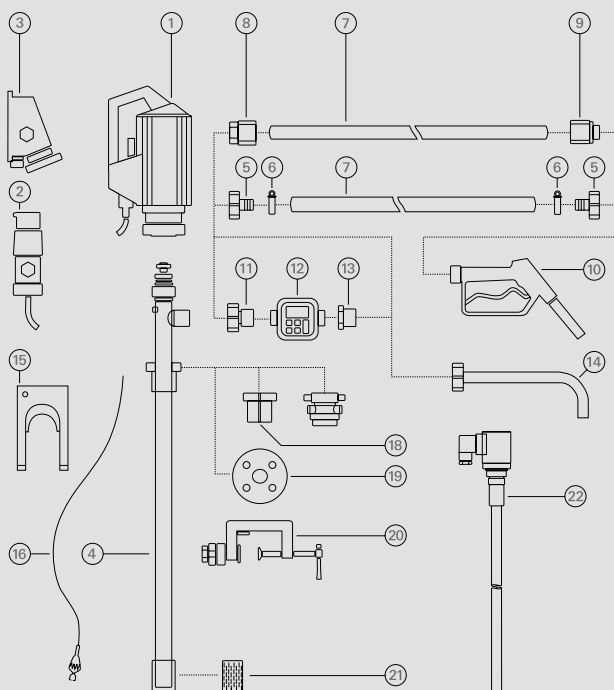

- 1 Drive motor
- 2 Explosion-proof plug
- 3 Explosion-proof socket
- 4 Pump tube
- 5 Hose connector
- 6 Hose clamps
- 7 Hose
- 8 Hose fittings
- 9 Hose fittings
- 10 Nozzle
- 11 Flow meter connection
- 12 Flow meter
- 13 Reducing piece
- 14 Discharge spout
- 15 Wall bracket
- 16 Equipotential bonding cable
- 17 Emission proof drum adapter
- 18 Drum adapter
- 19 Installation flange
- 20 Clamping device
- 21 Foot strainer
- 22 Level switch

Distributor:

grün-pumpen gmbh
Otto-Schott Str. 19
D-97877 Wertheim
Telefon +49 93 42 9 35 16-0
Telefax +49 93 42 9 35 16-29
info@gruen-pumpen.de
www.gruen-pumpen.de

Handelsregister:
Reg. Gericht Mannheim
HRB 570326
Sitz der Gesellschaft:
Wertheim
Geschäftsführer:
Ralph Dostmann,
Dr. Thomas Sigel
USt.IdNr. DE 160765854

g[®]
grün-pumpen
 take out, what's in.