

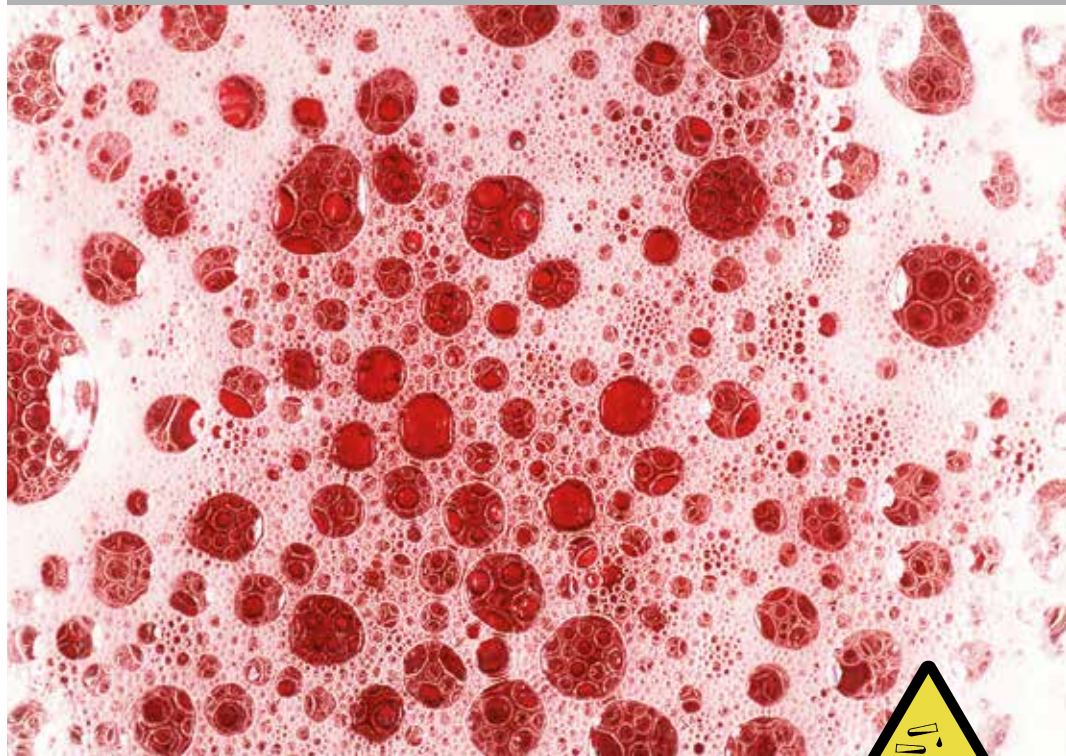

SEALLESS

DRUM PUMPS PVDF

FOR HIGH AGGRESSIVE LIQUIDS
THE RIGHT DRUM PUMPS



- This saves maintenance costs
- This avoids malfunctions
- This saves time
- This saves money

**If you have such applications,
take only the best.**



... and environment.

PVDF drum pumps take no ...



fright at any application ...



Advantages for the reliability

This saves maintenance costs

- robust coupling
- strong shaft
- stainless steel for stressed parts
- new development without seal



Advantages for the operational safety

This avoids malfunctions

- optional magnetic clutch for hermetical sealed pump
- strong connection motor-pump



Advantages for the user

This saves time

- quick release coupling
- no problems with failed threads



Advantages for the customer

This saves money

- one supplier for the most applications
- one motor for all types of impeller
- less equipment required

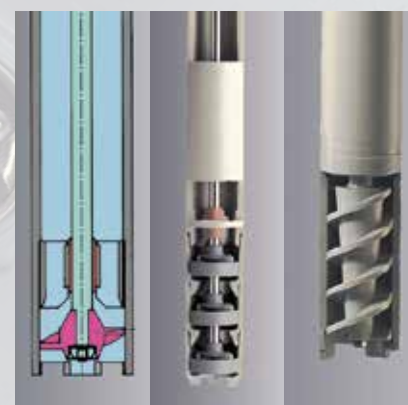

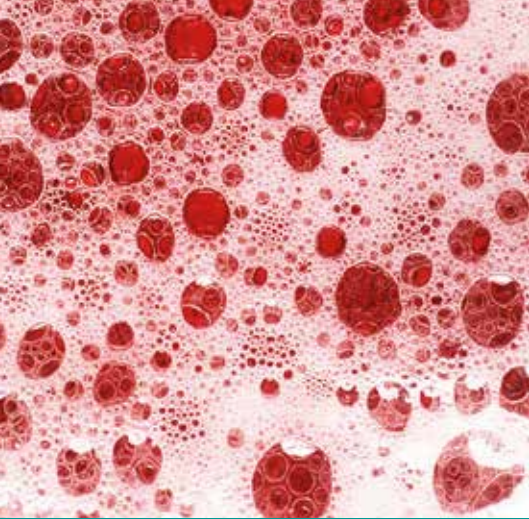

DRUM PUMPS PVDF

FOR HIGH AGGRESSIVE LIQUIDS
THE RIGHT DRUM PUMPS

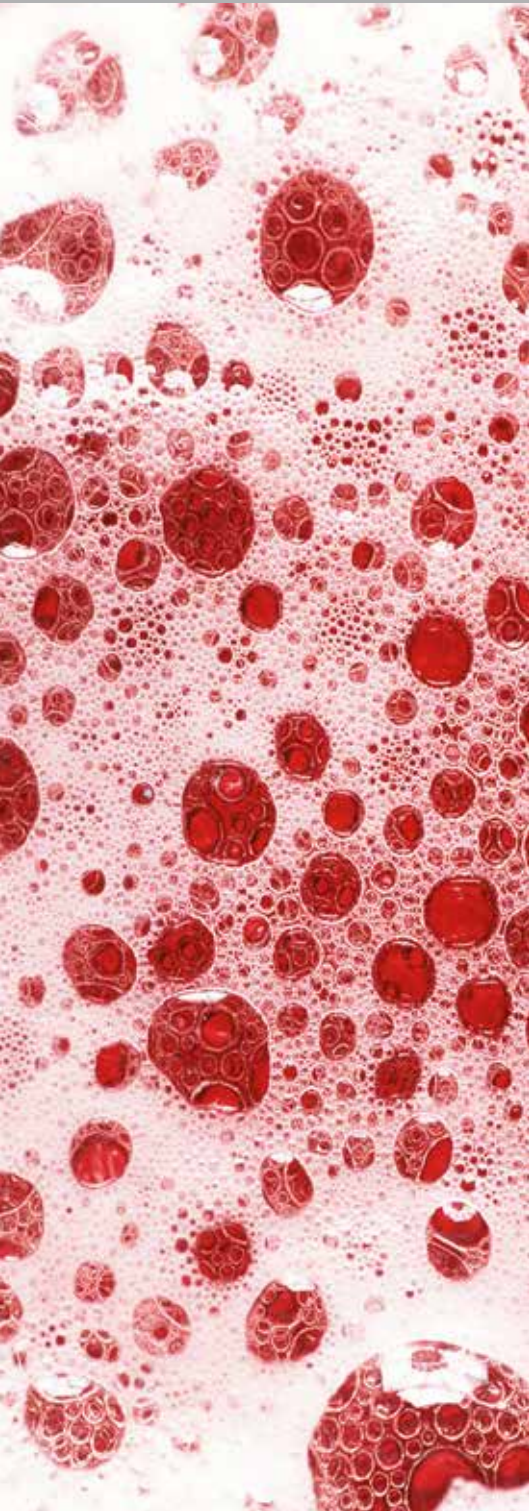

SEALLESS



- **acid, concentrated**
- **bases, concentrated**
- mineral oil
- colours
- emulsions
- dispersions
- suspensions
- fluids of medium viscosity
- cosmetics



For high aggressive liquids...

Version A, R column 1-2, page 7

SL-PVDF:

For transfilling and draining of drums and containers.

The perfect drum pump for the most thin liquids. Version A for high flow rate, Version R for high pressure, with foot valve for complete drainage.

Recommendation:

For heavy liquids the strong motor p400-A.



**For high aggressive and li-
quids of medium viscosity...**

Version S column 3, page 7

SL-PVDF-S:

The feed screw (S) is dedicated for liquids of medium viscosity ($\eta > 200$ mPas), if the impeller types A and R reach their limitations.

With induction motor ideal combination for gentle dealing with the liquid.

Recommendation:

Induction motor with frequency inverter, for variable flow rate.

Sealless pumping units

Sealless pump tubes from grün are reliable without using a mechanical seal and are suitable for almost any aggressive, low viscosity media. Our sealless pumping units are available in PP, PVDF, stainless steel (SS) and aluminium (Alu) material versions.

(Separate brochure for each material available).



- **optimised in price**
- **short and occasional usage**
- **it likes light and thin liquids**
- **opt. LVR: low voltage release for advanced safety**
- **opt. SR: speed reducer for simple flow rate variation**

Design PVDF:

The pump tube (3) is divided by the inner tube into sections to separate the fluid under pressure (3 flow channels) and the low pressure section (wave channel).



- **the ideal drive**
- **big resources in power and durability**
- **quick working and saving time**
- **opt. LVR: low voltage release for advanced safety**
- **opt. SR: speed reducer for simple flow rate variation**
- **opt. IP 54: 230V**
- **Order-No. 500-0052**

Advantages of sealless drum pumps

► Cleaning the pumping unit is greatly facilitated; the risk of fluid carry-over when moving the pump to a different container is minimized.

► The build-in webs add considerable rigidity to the pump tube, resulting in greatly improved mechanical stability of the pumping unit.

► No bearings in the wave channel.

► Motor power is transferred by proven, robust coupling (1) with curved teeth over the stainless steel coupling element (2) with a large double bearing.

► Of course, the sealless pump tubes are fully compatible with the sealed models, allowing you to use the pumping units with any motor from grün product range.

► Depending on the application you can select one of 3 different types of impellers: axial (A), radial (R) and feed screw (S).



- **the power drive**
- **variable speed**
- **starting knob fixable**
- **for heavy duty**
- **easy handling**
- **economical air consumption**

Product profile

A drum pump always consists of a pump tube and a motor. These components are connected by means of a quick coupling. Any pump tube can be used with any motor.

Selecting the right order-no.

In the general order-no., for example 500-00XX, fill in the specific numbers for your choice.
Example: p400-A 230V: Order-No. 500-0024



- **the silent marathon worker**
- **ideal for viscous liquids**
- **smooth product treatment with feed screw**
- **voltage 230 V (1-ph) and 400 V (3-ph)**
- **opt.: with frequency inverter**
- **opt.: Ex-proof versions**

New connection technology: metal replaces plastic, robust for use in harsh environments

Motor	Pump tube	1		2		3	
		SL-PVDF-A	SL-PVDF-R	SL-PVDF-R	SL-PVDF-S		
p310	Performance curve	A100	R100				
Power (W)	520	max	max				
Voltage (V)	230 / 120	100	90				
Protection	IP 24	6	14				
LVR*	optional	1,3	1,6				
Weight (kg)	3,5	300	250				
Weight (kg)	3,5	1,8	1,8				
Temperature (°C)		80	80				
Order-No.	500-00XX	Order-No.	Order-No.				
Voltage (V)	230 120						
p310 (LVR)	16 28	680-0001	685-0001				
p310-A	17 29	680-0002	685-0002				
p310-A-SR	54 -	680-0003	685-0003				

Motor	Pump tube	1		2		3	
		SL-PVDF-A	SL-PVDF-R	SL-PVDF-R	SL-PVDF-S		
p400	Performance curve	A200	R200	S200			
Power (W)	850	max	max	max			
Voltage (V)	230 / 120	110	100	55			
Protection	IP 24	8	20	10			
LVR*	optional	1,6	2,0	1,5			
Weight (kg)	4	800	700	700			
Weight (kg)	4	1,8	1,8	2			
Temperature (°C)		80	80	80			
Order-No.	500-00XX	Order-No.	Order-No.	Order-No.			
Voltage (V)	230 120						
p400 (LVR)	23 25	680-0001	685-0001	680-0006			
p400-A	24 26	680-0002	685-0002	680-0007			
p400-A-SR	56 -	680-0003	685-0003	680-0008			

Motor	Pump tube	1		2		3	
		SL-PVDF-A	SL-PVDF-R	SL-PVDF-R	SL-PVDF-S		
d600	Performance curve	A600	R600	S600			
Power (W)	600	max	max	max			
Pressure (bar)	3-7	90	80	60			
Capacity Q (l/min)		7	15	8			
Delivery head H (mWS)		1,6	2	1,5			
Density ϕ (kg/l)	10	800	700	700			
Viscosity η (mPas)							
Consumption of air (l/s)							
Weight (kg)	1,7	1,8	1,8	2			
Weight (kg)	1,7	1,8	1,8	2			
Temperature (°C)		80	80	80			
Order-No.		Order-No.	Order-No.	Order-No.			
L (mm)							
d600	520-0016	680-0001	685-0001	680-0006			
		680-0002	685-0002	680-0007			
		680-0003	685-0003	680-0008			

Motor	Pump tube	1		2		3	
		SL-PVDF-A	SL-PVDF-R	SL-PVDF-R	SL-PVDF-S		
pd500	Performance curve		S500				
Power (W)	see below		max				
Voltage (V)	230 / 400		15				
Protection	IP 54		7				
Overload	1 ph: yes		1,3				
release	3 ph opt.		1500 (min 100)				
Weight (kg)	5						
Weight (kg)	5		2				
Temperature (°C)			80				
Order-No.			Order-No.				
L (mm)							
d500-1 550W	500-0044		680-0006				
			680-0007				
d500-3 370W	500-0039		680-0008				

* LVR: Low voltage release (restart protection)

Other voltages on demand.

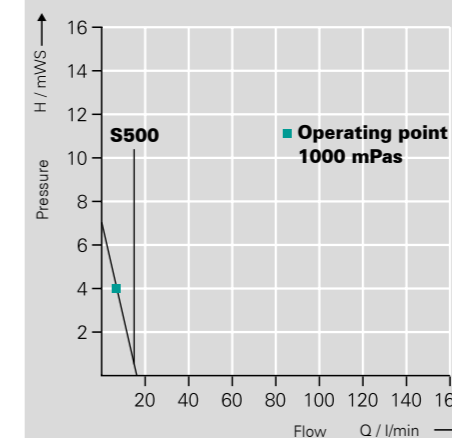
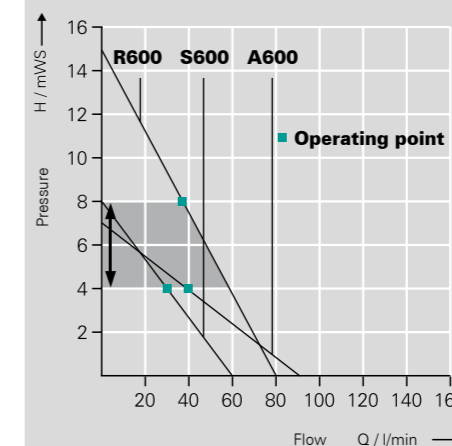
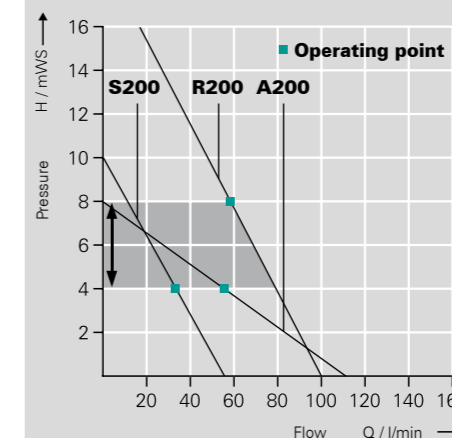
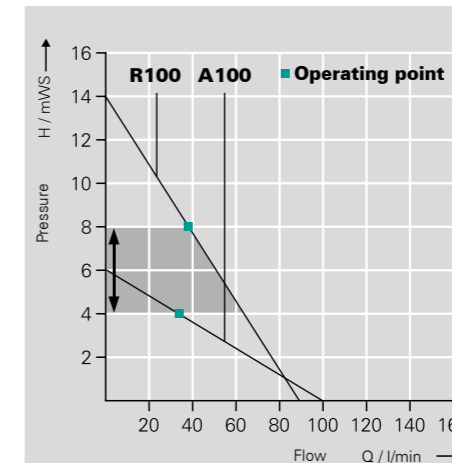
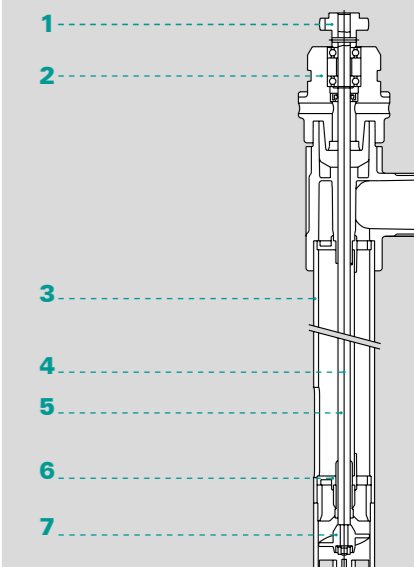
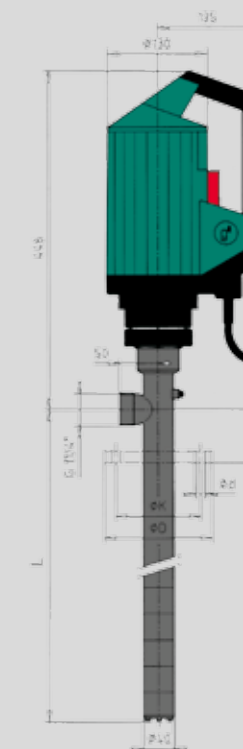

Table of materials

Description	Pump tube version
1. Curved teeth coupling	PA
2. Coupling element	PVDF/SS
3. Pump tube with flow and wave channel	PVDF
4. Drive shaft	HC
5. Wave channel	PVDF
6. Slide bearing	PTFE
7. Impeller	ETFE



Cross-section of pump:
When fluid enters the wave channel, a surge hole allows it to escape into the fluid area surrounding the pumping unit. In the wave channel is no overpressure and the fluid level in both (wave channel and drum) is always the same. For this reason the pump doesn't need a seal between drive shaft and housing.



**Mechanical sealed (MS) pumps
in separate catalogue.**



ACCESSORIES

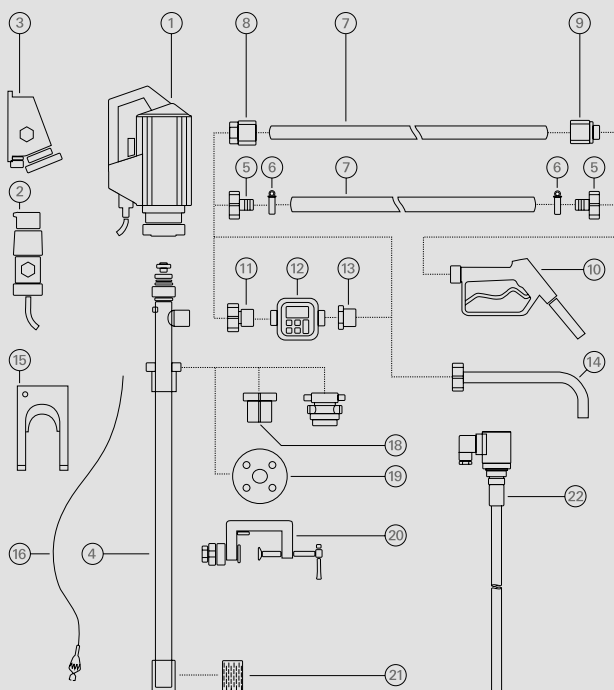

- 1 Drive motor
- 2 Explosion-proof plug
- 3 Explosion-proof socket
- 4 Pump tube
- 5 Hose connector
- 6 Hose clamps
- 7 Hose
- 8 Hose fittings
- 9 Hose fittings
- 10 Nozzle
- 11 Flow meter connection
- 12 Flow meter
- 13 Reducing piece
- 14 Discharge spout
- 15 Wall bracket
- 16 Equipotential bounding cable
- 17 Emission proof drum adapter
- 18 Drum adapter
- 19 Installation flange
- 20 Clamping device
- 21 Foot strainer
- 22 Level switch

Distributor:

grün-pumpen gmbh
Otto-Schott Str. 19
D-97877 Wertheim
Telefon +49 93 42 9 35 16-0
Telefax +49 93 42 9 35 16-29
info@gruen-pumpen.de
www.gruen-pumpen.de

Handelsregister:
Reg. Gericht Mannheim
HRB 570326
Sitz der Gesellschaft:
Wertheim
Geschäftsführer:
Ralph Dostmann, Dr. Thomas Sigel
USt.IdNr. DE 160765854

g[®]
grün-pumpen
 take out, what's in.